

## Part. S0567

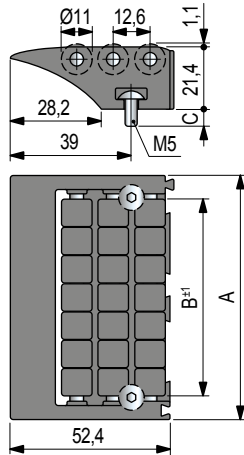

### End transfer module (with lip)



#### Code

A mm	B mm	C mm	Frame and Rollers in acetal Rex-HP (dark grey)
85	67,6	Without screws	<b>688792</b>
		13	<b>688812</b>
115	97	Without screws	<b>687382</b>
		13	<b>677322</b>

- Material: roller pins and screws in austenitic stainless steel.
- Modularity: snap-on assembly with Part. S0568.
- Packaging: 10 pieces.
- Weight: A=85: 0,09, A=115: 0,11.

## Part. S0672



### End transfer module (with lip)

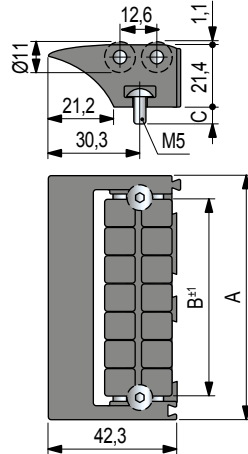

#### Code

A mm	B mm	C mm	Frame and Rollers in acetal Rex-HP (dark grey)
85	67,6	Without screws	<b>687412</b>
115	97	Without screws	<b>687432</b>

- Material: roller pins and screws in austenitic stainless steel.
- Modularity: snap-on assembly with Part. S0568.
- Packaging: 10 pieces.
- Weight: A=85: 0,09, A=115: 0,11.

### Fixing

Screws are tightened with an hexagon key inserted between rollers.

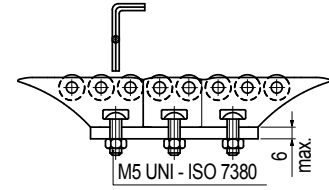

### Head to tail transfer of small and light products.

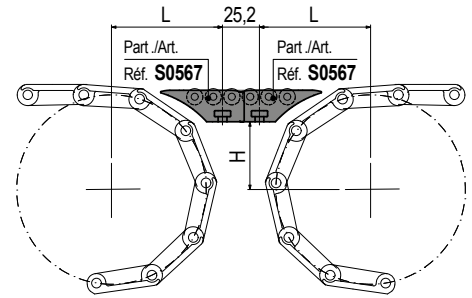

L and H see page S0164.

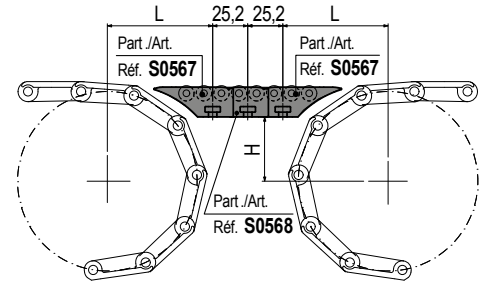

L and H see page S0164.

### Compact version.

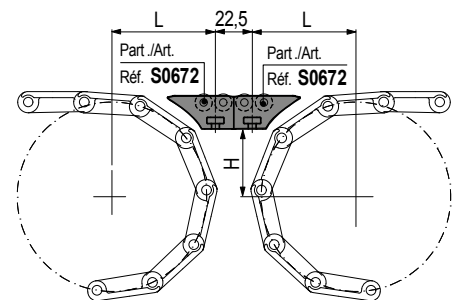

L and H see page S0166.

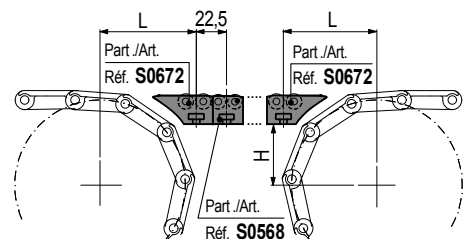

L and H see page S0166.

- Head to tail transfer of big and heavy products.

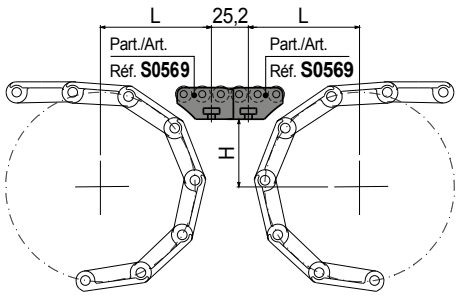

L and H see page S0164.

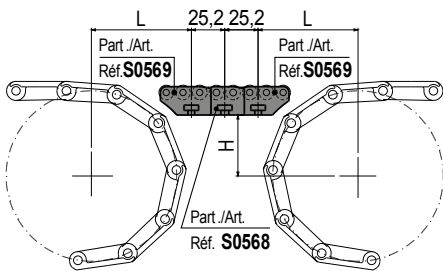

L and H see page S0164.

- 90° transfer of small and light products.

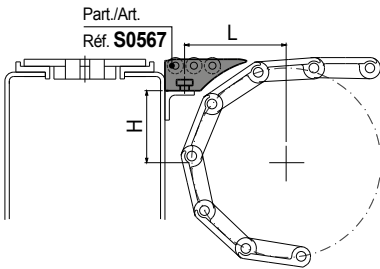

L and H see page S0164.

Compact version.

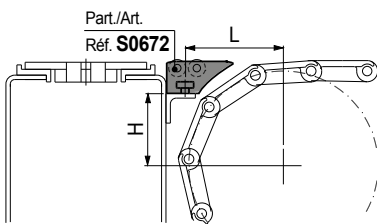

L and H see page S166.

- 90° transfer of big and heavy products.

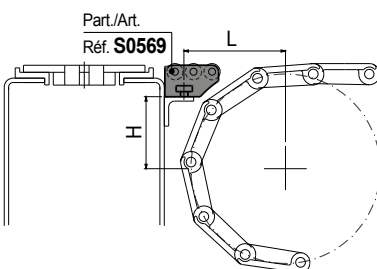

L and H see page S0164.

## End transfer module

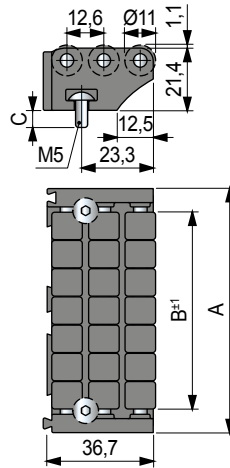

### Code

A mm	B mm	C mm	Frame and Rollers in acetal Rex-HP (dark grey)
85	67,6	Without screws	<b>605922</b>
		13	<b>601092</b>
115	97	Without screws	<b>687392</b>

- Material: roller pins and screws in austenitic stainless steel.
- Modularity: snap-on assembly with Part. S0568.
- Packaging: 10 pieces.
- Weight: A=85: 0,09, A=115: 0,10.

## Part. S0569



## End transfer module

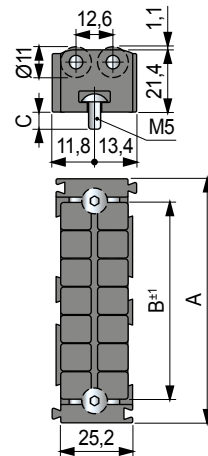

### Code

A mm	B mm	C mm	Frame and Rollers in acetal Rex-HP (dark grey)
85	67,6	Without screws	<b>605912</b>
		13	<b>601082</b>
115	97	Without screws	<b>687402</b>

- Material: roller pins and screws in austenitic stainless steel.
- Modularity: snap-on assembly with Part. S0567 - S0569 - S0672.
- Packaging: 20 pieces.
- Weight: A=85: 0,08, A=115: 0,10.

## Part. S0568

